



THE CONCEPT TO COMBAT WEAR AND TEAR

# DILLIDUR

TECHNICAL INFORMATION NO. III/2007

DILLINGER HÜTTE GTS







April 2007



---

## CONTENTS

5

**A Longer Life for your Machinery**

12

**The Manufacture of DILLIDUR**

Melting the Steel  
Shaping into Heavy Plate  
Hardening

17

**The Material Properties of DILLIDUR**

Hardness and Strength  
Toughness  
Through Thickness Hardening  
High-Temperature Strength

20

**The Processing of DILLIDUR**

Cold Forming  
Hot Forming  
Thermal Cutting  
Welding  
Machining  
Nitriding

49

**Literature**

50

**Index**



**Figure 1:** Excavator shovel made of DILLIDUR-V steels in the harsh conditions of open-cast mining  
(Illustration used with the kind permission of Schlüter Baumaschinen, Erwitte, Westphalia, Germany)



---

## A LONGER LIFE FOR YOUR MACHINERY

Quarries and mines, gravel pits, construction, iron and steel – in no other industries are valuable machines and installations literally “worn out“ as much as they are in these sectors.

Slide conveyors, chutes, silos, deflectors, steel plating, screen plates, cutting edges, dump trucks, loading shovels etc. are components which are expected to provide a maximum of resistance to wear. Therefore, the quality and service life of the machines and their components is particularly dependent on the materials they are made of.

We would like to introduce to you a group of steels combining

requirements which used to be difficult to reconcile, such as high wear resistance coupled with a minimum use of material and excellent processing properties: the DILLIDUR steels from DILLINGER HÜTTE GTS.

Renowned manufacturers of construction machinery, conveyor systems and processing plants use them and place their confidence in the decades of experience that DILLINGER HÜTTE GTS has in the production of wear-resistant steels.

The DILLIDUR concept was designed for a variety of areas

of application. Therefore, DILLIDUR steels are available in a wide range of hardness levels to cover each set of requirements: DILLIDUR 275 C, 325 L, 400 V, 450 V and 500 V.

Information about the special quality for pavement moulds (DILLIDUR 275 SFX) can be found in the corresponding data sheet.

Our delivery program shows in which dimensions our DILLIDUR steels are normally deliverable. In addition, special dimensions are possible on request.



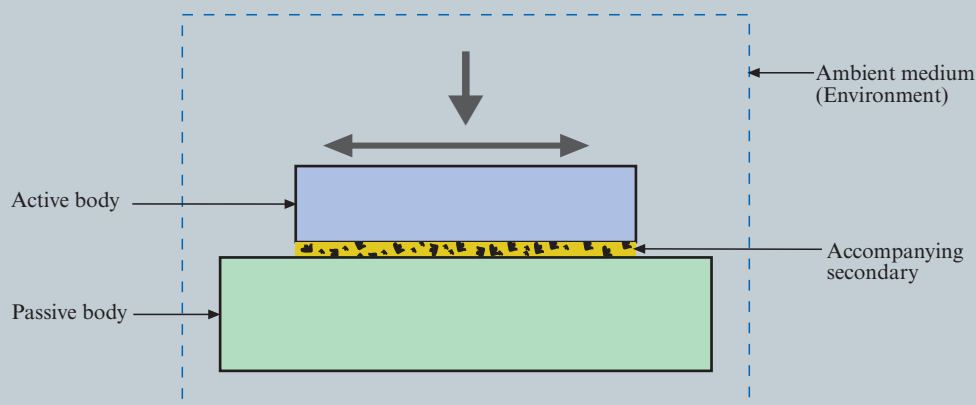
The decision on which DILLIDUR steel is most suitable depends on a precise knowledge of the conditions of use and the processing options.

In your analysis of cases of wear, you should take into account the many facets of tribological processes, which means that a comprehensive

investigation of all components directly involved is necessary. In this investigation, the former standard DIN 50320 "Wear" will help. Such a "tribological system" is illustrated in diagram form in Figure 2. Unlike the properties of hardness, strength etc., which can be regarded as characteristics of the material, wear from tribological loading

results from the interaction of all parts of a technical structure that are involved in the wear process, and can only be described by "system-related" wear characteristics. It is thus a general principle that "wear is not a characteristic of the material, it is always a characteristic of the system!"

**Figure 2:** Structure of a general tribological system <sup>1)</sup>



<sup>1)</sup> Reproduced by permission of DIN Deutsches Institut für Normung e.V.  
The definitive version for the implementation of this standard is the edition bearing the most recent date of issue, obtainable from Beuth Verlag GmbH, 10772 Berlin, Germany. Translated by DILLINGER HÜTTE GTS. This translation has not been checked by DIN Deutsches Institut für Normung e.V., Berlin.





As can be seen in Figure 2, there are generally four elements involved in a wear process. These elements form the actual structure of the tribological system, and they fundamentally affect the selection of a suitable wearing plate (passive body).

The following questions and explanations are designed to help you to diagnose this structure, and then to select a material which is appropriate for the wear situation.


















- What kind of material (stones, silica, gravel, coal, sludge, flour, sugar etc.) acts on the wear plate with what severity, or what is the nature of the active body (the item which the metal plate comes into contact with)?
- What is the type of wear load (sliding, rolling, pushing, flowing) and how high are the forces that affect the material (velocity, pressure, temperature, duration of loading, etc.)?
- Which accompanying secondaries are also involved (water, oil, acid, air, abrasive products etc.)?
- In what kind of environment does the wearing process take place (moist, saline, dry air, ambient temperature etc.)?

Depending on the cause of wear, wear is subdivided into types of wear and wear mechanisms.

On the basis of the standard DIN 50320, which is officially no longer valid but nevertheless instructive, Table 1 shows a compilation of the major types of wear that could result for the different tribological loads, with the effective wear mechanisms marked.



**Table 1:** Subdivision of the wear area, based on the former standard DIN 50320 <sup>1)</sup>

System structure	Tribological cause of wear (Symbols)	Type of wear	Acting mechanisms (singly or combined)			
			Adhesion	Abrasion	Surface destruction	Tribo-chemical reactions
– Solids – Accompanying secondary (complete separation of substances) – Solids	Sliding Rolling Impact 	–	–	–	■	□
– Solids – Solids (solid friction, boundary friction, mixed friction)	Sliding 	Slide abrasion	■	□	□	■
	Rolling 	Rolling wear	□	□	■	□
	Oscillation 	Oscillation wear	■	■	■	■
	Impact 	Impact wear	□	□	■	□
– Solids – Particles		Abrasive Impact wear	–	■	■	□
	Sliding 	Abrasive sliding wear	–	■	–	□
– Solids – Solids and particles	Sliding 	Three-body abrasive wear	□	■	■	□
	Rolling 		□	■	■	□
	Impact 		□	□	■	□
– Solids – Particles – Liquid	Flowing 	Hydro-abrasive wear	–	■	■	□
– Solids – Particles (gas)	Flowing 	Jet blasting wear	□	■	■	□
	Flowing Impact 	Impact wear Oblique blasting wear	□	■	■	□
– Solids – Liquids	Flowing Oscillating 	Cavitation-erosion	–	–	■	□
	Impact 	Erosion by impingement	–	–	■	□
	Flowing 	Liquid-erosion	–	–	□	■
– Solids – Gas	Flowing 	Gas erosion	–	–	–	■

■ Mainly active  
□ Sometimes active

<sup>1)</sup> Reproduced by permission of DIN Deutsches Institut für Normung e.V.  
The definitive version for the implementation of this standard is the edition bearing the most recent date of issue, obtainable from Beuth Verlag GmbH, 10772 Berlin, Germany. Translated by DILLINGER HÜTTE GTS. This translation has not been checked by DIN Deutsches Institut für Normung e.V., Berlin.



Types of wear mainly describe the kinetics and structure of tribological systems, and wear mechanisms result from the interaction of materials and energy between the active and passive bodies, influenced by the accompanying secondary and the ambient medium. The following distinctions are made<sup>1)</sup>:

- Adhesion: caused by local bonding of the contact surfaces, e.g. “plucking“
- Abrasion: score grooving of the material as a result of abrasive loading
- Surface destruction: fatigue and formation of cracks in the surface as a result of dynamic load, e.g. “pitting“
- Tribo-chemical reaction: occurrence of reaction products due to tribological loading in chemical reaction with the environment, e.g. “oxidation“.

Each of these mechanisms solicitation of the material in a different way and requires a specific optimisation of the individual material characteristics, e.g. hardness to fight abrasion and/or toughness to fight surface erosion.

A knowledge of the structure of a tribological system serves as an aid to diagnose wear processes and to reduce them by suitable means, if possible as soon as the design stage of a machine.

However, an exact prediction of wear processes and wear rates is usually extremely difficult since the number of facets of the process is almost unlimited. This means that, in spite of long experience, it is usually only possible to provide reliable wear data by testing the material in practical use.

In addition to the selection of material appropriate to the

causes of wear, you should take into account that design, operating and process-related measures can also help to achieve a significant reduction to wear.

For example, changing the transport velocity of bulk material in a chute system can influence the dumping parameters, and thus the angle of impact into a charging hopper. This in turn changes the proportion of impact and abrasive wear, and thus possibly the rate of wear (operating measure). Similarly, however, it is also possible to change the angle of inclination of the charging hopper wall (design measure), which could also change the rate of wear.

Passive wear protection measures which lead to self-protection by the abrasive material, e.g. by fixing steps (batons) to the wall of the charging hopper, can also help to reduce component wear.

<sup>1)</sup> Reproduced by permission of DIN Deutsches Institut für Normung e.V.  
The definitive version for the implementation of this standard is the edition bearing the most recent date of issue, obtainable from Beuth Verlag GmbH, 10772 Berlin, Germany. Translated by DILLINGER HÜTTE GTS. This translation has not been checked by DIN Deutsches Institut für Normung e.V., Berlin.



In addition to the wear-resistant characteristics of a steel such as hardness, ductility, resistance against crack formation and propagation, the following criteria for decision also play an important role in selection:

- Weldability
- Cold forming capacity
- Hot forming capacity
- Machinability
- Toughness
- Economic effectiveness

DILLIDUR steels offer you an ideal compromise between high wear resistance and optimum workability. This helps to save material and processing costs.

To make the selection of the right DILLIDUR steel easier, Table 2 compares the properties of the individual DILLIDUR steels. The details given apply for plate thickness of less than 25 mm and are merely intended as a guide. However, the relative

ratio between the individual steel qualities does not change significantly when the thickness is changed.

A detailed explanation of those properties is given in the corresponding sections of this brochure.

**Table 2:** Assistance in selecting the DILLIDUR grade most appropriate for your set of requirements

DILLIDUR	275 C	325 L	400 V	450 V	500 V
Wear resistance <sup>1)</sup>	+++	+	++	++(+)	+++
Weldability	0	+	+++	++	+
Cold forming capacity	+	++	++	++	+
Hot forming capacity	++	++	0	0	0
Machinability	++	++	++	+	0
Toughness	0	+	++	+(+)	

(+++ = very good, ++ = good, + = satisfactory, 0 = not advisable if this property is especially important.)

<sup>1)</sup> Mainly applies to abrasive wear (measured wear resistance under laboratory conditions)



Because of their special micro-structure and hardness, the wear resistance of DILLIDUR steels is up to 5 times higher than that of conventional steels (see Figure 3).

Therefore, modern steels such as DILLIDUR offer designers possibilities formerly difficult to achieve, enabling them for instance to slim down their designs and increase the wear resistance where it is necessary.

Similarly, it can be seen in Figure 3 that the adage: “The harder the steel, the better its wear resistance“ has only limited validity. This is due to metallurgical differences in the microstructure and applies generally for all wear resisting steels.

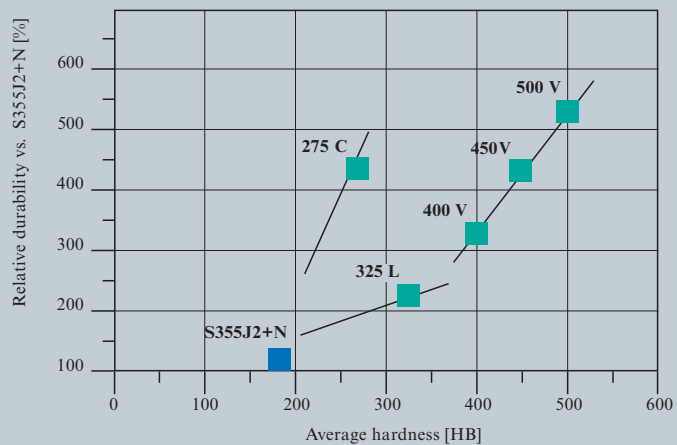
In examinations with the wear tank method (abrasion with dry gravel under laboratory conditions), the measured relative

wear resistance in relation to the structural steel S355J2+N was compared with the average hardness of the tested materials. The conclusion was that an increase in hardness only correlate with increased wear resistance when comparisons are

made within a specific steel quality (C, L or V).

This can be explained by the fact that the hardness of a steel can be achieved in different ways (see section “The Manufacture of DILLIDUR“, p. 12ff).

**Figure 3:** Relative durability of DILLIDUR steels by comparison with S355J2+N





## THE MANUFACTURE OF DILLIDUR

The high degree of hardness displayed by DILLIDUR steels is not only achieved by selective alloying, but also by special manufacturing processes. After rolling, the heavy plates are hardened by controlled heat treatment. All processes involved - steel production, shaping into heavy plate and hardening - are exactly combined for each steel melt, thus providing optimum control of the material microstructure and the best possible characteristics.

### Melting the Steel

After careful hot metal desulphurization, DILLIDUR steels are

produced by melting in a top-blowing basic oxygen process, then treated by ladle metallurgy and, for usual plate dimensions, cast by continuous casting. For very thick, heavy plates, ingot casting is also available.

A low phosphorus and sulphur content are both prerequisites for high toughness. As a rule, the phosphorus content is below 0,020 % and the sulphur content below 0,005 %. The required alloy content is exactly adjusted in the ladle as well, with a view to an optimum combination of mechanical values and good machinability.

Particular attention is paid to the carbon equivalent (CEV, PCM or CET), which goes up together with the alloy content. Low carbon equivalent values indicate a good weldability. However, a minimum of alloy elements, which increases with the plate thickness, is necessary to ensure sufficient hardening as a result of the final heat treatment.

Indicative values of the carbon equivalent of DILLIDUR 275 C, 325 L, 400 V, 450 V and 500 V are shown in Table 3.

**Table 3:** Carbon equivalent of DILLIDUR 275 C, 325 L, 400 V, 450 V and 500 V (indicative values)

DILLIDUR	275 C	325 L	400 V					450 V			500 V		
Thickness [mm]	40	40	10	25	40	80	120	10	40	80	10	40	80
CEV	0.80	0.78	0.37	0.46	0.51	0.61	0.64	0.46	0.53	0.65	0.47	0.52	0.67
CET	0.66	0.44	0.28	0.31	0.33	0.35	0.36	0.33	0.36	0.39	0.36	0.37	0.42
PCM	0.62	0.37	0.23	0.25	0.27	0.30	0.31	0.29	0.32	0.35	0.34	0.35	0.39

#### Carbon equivalent:

$$CEV = C + Mn/6 + (Cr + Mo + V)/5 + (Cu + Ni)/15$$

$$CET = C + (Mn + Mo)/10 + (Cr + Cu)/20 + Ni/40$$

$$PCM = C + Si/30 + (Mn + Cu + Cr)/20 + Mo/15 + Ni/60 + V/10 + 5 \cdot B$$



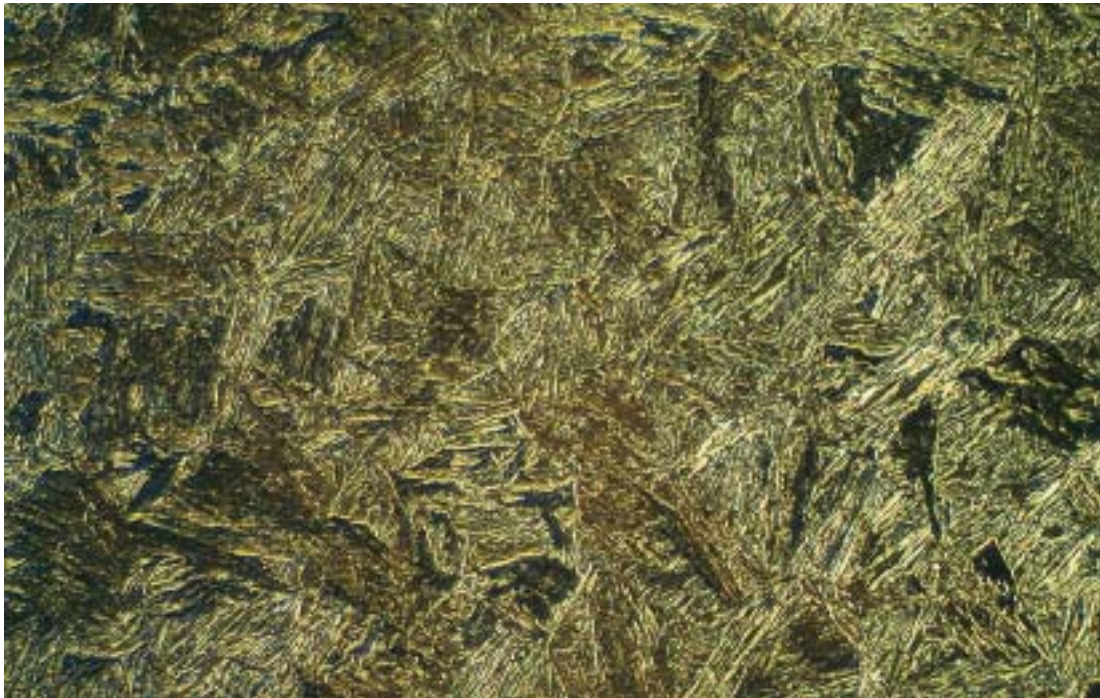
### Shaping into Heavy Plate

DILLINGER HÜTTE GTS has two of the most powerful rolling stands in the world. The slabs produced in the steel works are rolled there according to a rolling schedule precisely defined and tuned to the respective chemical composition of the steel. Thanks to the high rolling

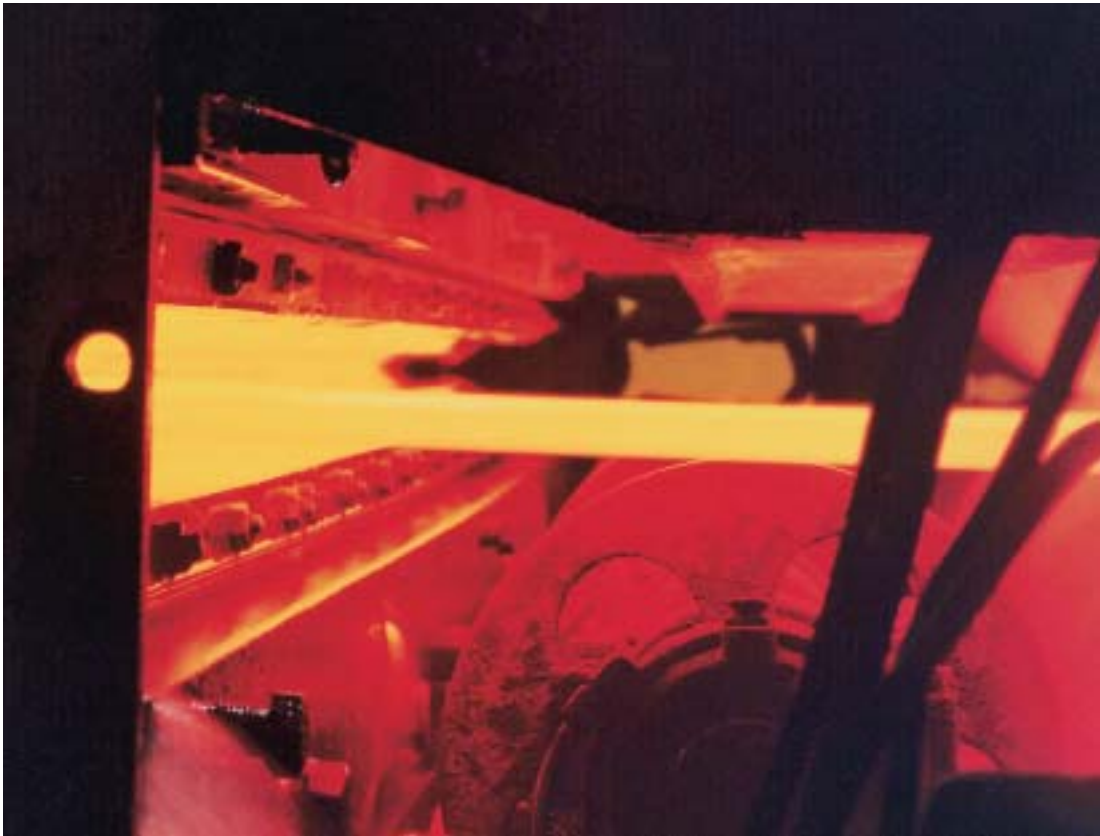
forces of up to 108,000 kN (11,000 metric tons), sufficient deformation is achieved in the core of the plate, even for large plate thickness.

The microstructure is then highly suitable for the subsequent hardening process and forms one of the prerequisites for the good homogeneity and

mechanical properties of DILLIDUR steels. The reproducibility of the rolling process in terms of rolling temperature, rolling force and thickness reduction ratio is ensured by accurate measurement and fast process control. These features are used to set the narrow dimension tolerances.



*Figure 4: The typical microstructure of DILLIDUR V steels magnified 500 times*



*Figure 5: An austenized DILLIDUR V plate enters the quenching device*





### **Hardening**

DILLIDUR 275 C is normalized and receives its hardness mainly from its carbon content. The microstructure of this type of steel is largely ferritic and pearlitic.

DILLIDUR 325 L is also normalized, but it receives its hardness from additional alloying, while the carbon content is kept low to improve weldability.

The microstructure of this normalized steel is largely bainitic.

The high hardness of DILLIDUR V steels is achieved not only through systematic alloying, it is also the result of a special manufacturing process. After rolling, the heavy plates are heated to austenitizing temperature and then cooled down with water in a special quenching device. A fast-running water film over the top and

bottom surface of the plate ensures extremely high cooling rates. This leads to a fine-grained, hard microstructure. Continuous and steady cooling results in a homogeneous hardness, basis of a high wear resistance.

The typical hardened microstructure of a DILLIDUR V steel is shown in Figure 4 on page 13.

Figure 5 shows an insight into the quenching device.



*Figure 6: Charging hopper of a crushing plant, walls made of DILLIDUR 400 V*



## THE MATERIAL PROPERTIES OF DILLIDUR

### Hardness and Strength

The hardness level of DILLIDUR steels far surpasses that of conventional steel.

Table 4 shows indicative values for hardness, yield strength, tensile strength, elongation at rupture and toughness.

In spite of their high tensile properties, DILLIDUR steels are not intended for security

relevant components. For this purpose high strength steels DILLIMAX are available.

### Toughness

In spite of their high hardness, DILLIDUR steels have sufficiently good toughness for their usual field of application. The impact toughness is highest for the low-carbon DILLIDUR V steels with a martensitic microstructure, and the toughness

level decreases gradually with increasing carbon content. Therefore, the impact toughness of DILLIDUR L is lower (bainitic microstructure) and that of DILLIDUR C is low because of the high carbon content. Even in wear resisting steels, the toughness under impact load or surface eroding impact wear may be decisive, e.g. in ventilation systems or in truck dumping bodies (see Figure 21, p. 38).

**Table 4:** Indicative values for hardness, yield strength, tensile strength, elongation at rupture and toughness for plate thickness below 25 mm

DILLIDUR	275 C	325 L	400 V	450 V	500 V
Hardness [HB] <sup>1)</sup>	275	320	400	450	500
Yield point Y.P. [MPa]	650	650	800	950	1100
Tensile strength U.T.S. [MPa]	950	1000	1200	1400	1600
Elongation A [%] <sup>2)</sup>	9	15	12	11	9
Impact toughness [J] <sup>3)</sup>	10	20	45	35	25

<sup>1)</sup> Average surface hardness

<sup>2)</sup> Round tensile test specimen, transverse

<sup>3)</sup> Charpy-V specimens, longitudinal at -20 °C



### Through-Thickness Hardening

To achieve outstanding mechanical properties, in this case a high hardness value in the core of the plate and homogeneous microstructure, it is necessary in addition to the extremely high cooling rates and very low amount of non-metallic substances and hydrogen, to provide a precisely tuned amount of alloying elements.

Chromium, molybdenum, manganese, vanadium and boron are particularly suitable for full hardening. The chemical composition of the DILLIDUR steels is designed to ensure that the reduction of hardness towards the core of the plate is as low as possible, taking into account the necessary limitation of the carbon equivalent for the sake of weldability.

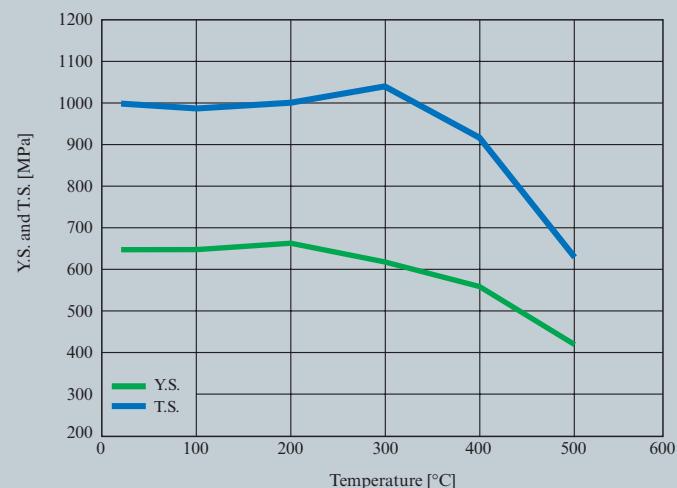
A high hardness penetration prevents wear from taking place too quickly from the surface to the core of the plate.

### High-Temperature Strength

Wear processes which are active at elevated temperatures require good high-temperature strength properties of the materials used. Even at high temperatures, the protection against wear has to be as good as possible to ensure long service life.

The „air hardeners“ DILLIDUR C and L can be used in permanent operation up to a temperature of 400 °C. On the basis of hot tensile tests for various plate thickness values, Figure 7 shows that DILLIDUR 325 L still has a strength of 630 MPa at this temperature.

**Figure 7:** Effect of temperature on the yield and tensile strength of DILLIDUR 325 L (auxiliary data, plate thickness = 20 mm)

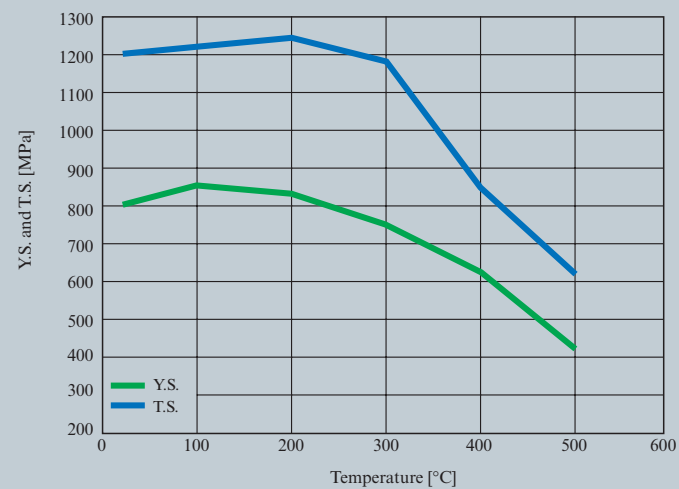




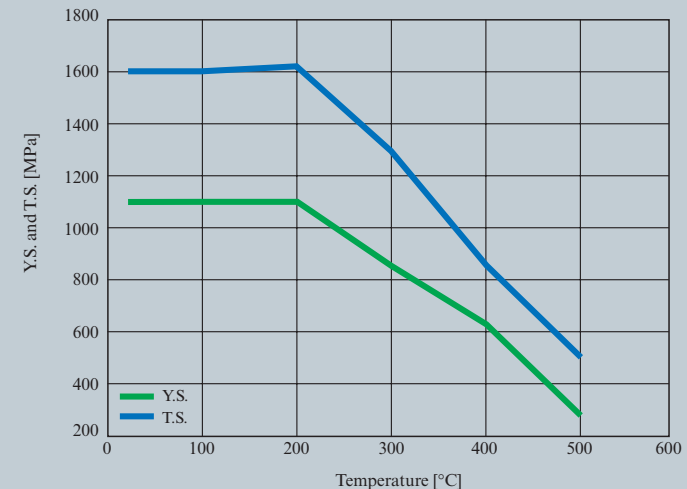
Because of their special heat treatment, DILLIDUR V steels cannot be used permanently at temperatures above 200 °C - 250 °C without losing hardness and strength.

By means of hot tensile tests for various plate thickness values, Figures 8 and 9 show the typical effect of temperature on the mechanical properties of DILLIDUR 400 V and DILLIDUR 500 V.

**Figure 8:** Effect of temperature on the yield and tensile strength of DILLIDUR 400 V (auxiliary data, plate thickness = 20 mm)



**Figure 9:** Effect of temperature on the yield and tensile strength of DILLIDUR 500 V (auxiliary data, plate thickness = 20 mm)





---

## THE PROCESSING OF DILLIDUR

DILLIDUR steels are well suited for processing in spite of their high degree of hardness. Nevertheless, certain processing guidelines apply to DILLIDUR steels. The user should ensure that his design, construction and processing methods are aligned with the material, correspond to the state-of-the-art that the fabricator has to comply with and are suitable for the intended use.

The following pages explain a number of fundamental principles and provide practical processing hints for DILLIDUR.

### **Cold Forming**

DILLIDUR steels are well suited for cold forming by bending in spite of their high hardness and strength. It must be taken into account that the force needed to form a given plate thickness increases with the yield strength of the steel. The elastic spring-back effect also increases. In order to avoid the risk of cracking from the edges, flame cut or sheared edges should be grounded in the area that is to be cold formed. It is also advisable to round the plate edge slightly on the outside of the bend coming under tension stress during bending. Because of the relatively high carbon content, the flame cut of DILLIDUR 275 C is very hard (approx. 600 HB) and brittle.

That's why the flame cut area should be worked off by about 3 mm for the cold forming.

Because of the different heat treatment conditions, the required minimum bending radius is not the same for DILLIDUR C, L and V steels (see Table 5) In addition, the minimum required bending radius and die opening for bending perpendicular to the rolling direction are lower than for bending parallel to it, which is due to the deformation process during rolling. The following minimum values for the bending radius can be used as a guide for DILLIDUR steels, assuming that the forming speed does not exceed 10 % expansion of the outer fibre per second.



**Table 5:** Minimum bending radius and die opening for cold forming of DILLIDUR steels

DILLIDUR	275 C		325 L		400 V		450 V		500 V	
	perp.	parallel	perp.	parallel	perp.	parallel	perp.	parallel	perp.	parallel
Position of bending line to rolling direction										
Bending radius	6 t	8 t	5 t	6 t	3 t	4 t	5 t	6 t	7 t	9 t
Die opening	14 t	18 t	14 t	16 t	10 t	12 t	14 t	16 t	16 t	20 t
Hot forming	possible		possible		-		-		-	

*Bending angle < 90°, t = plate thickness, forming time > 2 sec (< 10 % expansion of outer fibre per second)*

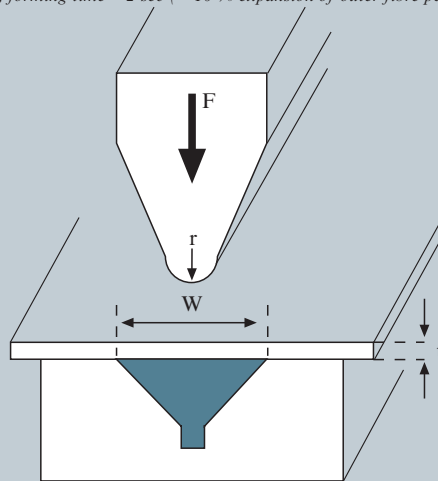




Figure 10: Continuous ship unloader in the harbour of DILLINGER HÜTTE GTS





### Hot Forming

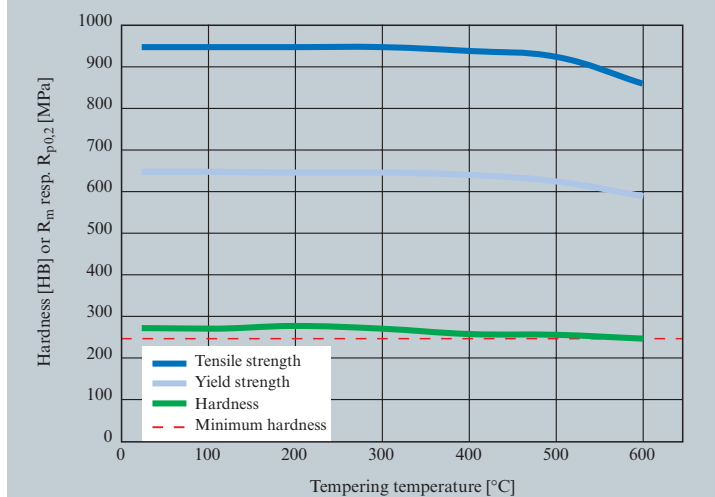
By hot forming we generally understand forming at temperatures at which a metallurgical alteration can be expected. For DILLIDUR 275 C and DILLIDUR 325 L this is the stress-relieving temperature (approx. 580 °C). For DILLIDUR V steels, because of the special hardening process, this limit is significantly lower (approx. 250 °C).

Since the yield strength of the steel decreases with increasing temperature, it may still be beneficial for DILLIDUR 275 C and DILLIDUR 325 L to carry out the forming process at high temperature in case of narrow bending radius and thick plates. The required forming force decreases in proportion to the temperature.

**DILLIDUR 275 C:** As the steel reaches its hardness by air cooling after normalization, hot forming is always possible without a loss of hardness if the steel is then normalized again or if an equivalent temperature control is maintained during hot forming. The temperature for

normalization is 880 to 950 °C. Without subsequent normalizing, the steel can be heated to about 600 °C without significant loss of hardness. Figure 11 shows the general change in the hardness and strength values for DILLIDUR 275 C in relation to the tempering temperature.

**Figure 11:** DILLIDUR 275 C: Effect of the tempering temperature on tensile strength, yield strength and hardness after the cooling down to the room temperature (auxiliary data)



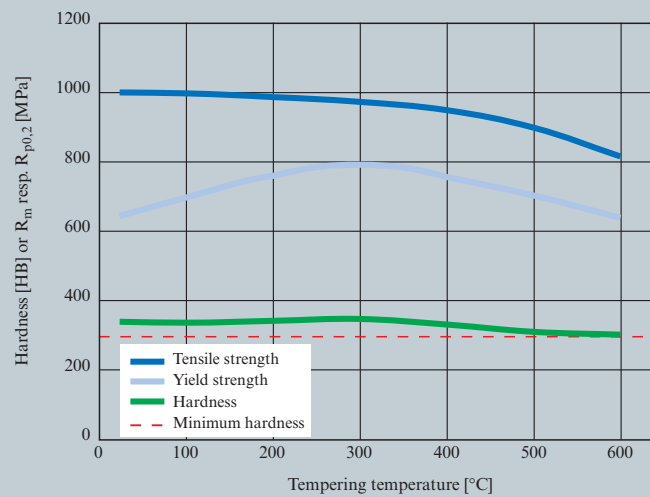


**DILLIDUR 325 L:** As the steel reaches its hardness by air cooling after normalizing, hot forming is always possible without a loss of hardness if the steel is then normalized again or if an equivalent temperature control is maintained during hot forming.

The temperature for normalization is 900 to 950 °C.

Without subsequent heat treatment, the steel can be heated up to about 600 °C without significant loss of hardness. The general change of hardness and strength with the tempering temperature are shown in Figure 12.

**Figure 12:** DILLIDUR 325 L: Effect of the tempering temperature on tensile strength, yield strength and hardness after the cooling down to the room temperature (auxiliary data)



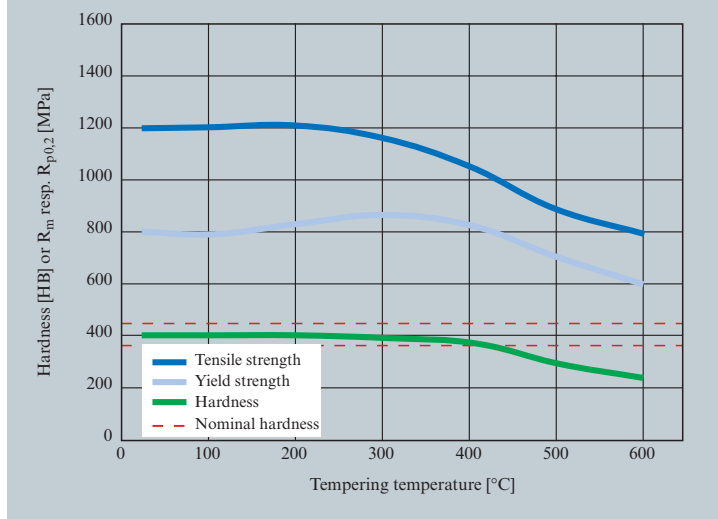


**DILLIDUR 400 V/500 V:** As the steel reaches its hardness by accelerated cooling from the austenitizing temperature, hot forming without a loss of hardness is only possible if the workpiece is then hardened again.

Due to the different heat treatment equipment of the processing factory and the geometry of the component, the cooling rate achieved is generally slower and the hardness lower than for plate manufacturing.

The original hardness and through-thickness hardening produced in the mill can generally not be reached again. Additionally there is a risk of distortion. For components which must be quenched during processing, the chemical composition can be adjusted accordingly in consultation with DILLINGER HÜTTE GTS.

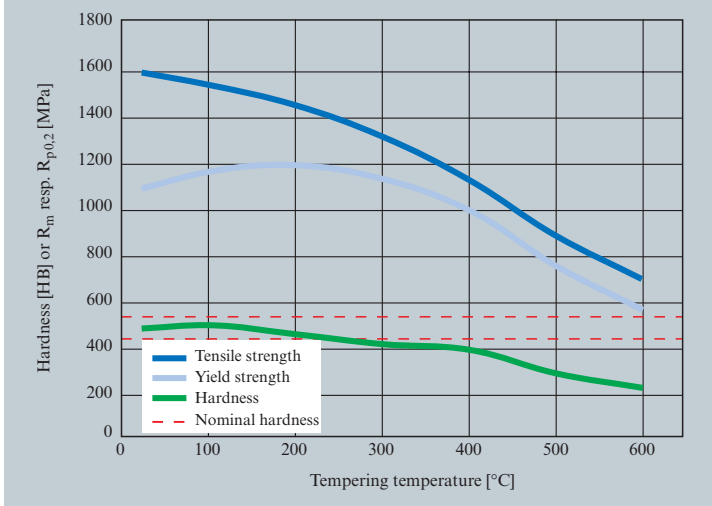
**Figure 13:** DILLIDUR 400 V: Effect of the tempering temperature on tensile strength, yield strength and hardness after the cooling down to the room temperature (auxiliary data)



Figures 13 and 14 show the general change of tensile strength, yield strength and hardness values for DILLIDUR 400 V and 500 V in relation to the tempering temperature.



**Figure 14:** DILLIDUR 500 V: Effect of the tempering temperature on tensile strength, yield strength and hardness after the cooling down to the room temperature (auxiliary data)



If hot forming of DILLIDUR V steels is necessary, it should as far as possible be carried out at a temperature between 880 and 950 °C.

During the subsequent hardening, a quick heat dissipation must be ensured and the formation of insulating layers of vapour avoided, in order to reach sufficient hardening across the thickness of the component.



### Thermal Cutting

Flame cutting, plasma arc cutting or laser cutting of DILLIDUR L and V steels is possible without any difficulty if carried out correctly and as long as appropriate tools in good working condition, suitable for the respective job are available. As different manufacturers have developed a variety of tools, you should note the respective settings and advice prescribed by the manufacturer in the cutting tables (nozzle selection, gas pressure, working methods, speed etc.).

The surface condition of the plates also has a marked influence on the flame cutting conditions and the cut face quality that can be achieved. Where high demands are placed on the cut face quality, it is nec-

essary to clean the top of the workpiece around the cut from scale, rust, paint and any other impurities.

**Oxycutting:** In this flame cutting method, the steel is heated to inflammation point with a gas and oxygen flame and then burned in a cutting oxygen jet. In this process, only an extremely narrow zone (< 1 mm) next to the cutting edge is heated to hardening temperature (austenized), and because of the extremely high flow of heat into the surrounding cold material, it is transformed into a hardened structure. This heat discharge can reach the cooling speed of quenching in water. The surrounding areas are tempered. We also speak of the so-called heat-affected zone (HAZ). The extreme differences in temperature can lead to stress and,

under unfavourable conditions, to hardness cracking. With increasing thickness and alloying content, flame cutting of DILLIDUR steels requires more care than conventional constructional steels.

Flame cutting must be carried out at a temperature high enough to avoid cracking.

The cooling speed is thereby reduced so that the austenized zone is not hardened so strongly and the shrinking stress is significantly reduced. The minimum preheating temperatures given in the table 6 have proved to be appropriate for oxyacetylene cutting.

Re-entering angles should be flame cut with a radius, in order to reduce the notch effect.

**Table 6:** Minimum preheating temperatures for flame cutting of DILLIDUR steels

Plate thickness [mm]	< 10	< 20	< 30	< 50	< 60	< 100
DILLIDUR 275 C	150 °C	150 °C	175 °C	225 °C	225 °C	225 °C
DILLIDUR 325 L	15 °C	75 °C	100 °C	120 °C	–	–
DILLIDUR 400 V <sup>1)</sup>	15 °C	15 °C	15 °C	75 °C	100 °C	100 °C
DILLIDUR 450 V <sup>1)</sup>	15 °C	15 °C	50 °C	75 °C	100 °C	125 °C
DILLIDUR 500 V <sup>1)</sup>	50 °C	50 °C	75 °C	100 °C	150 °C	180 °C

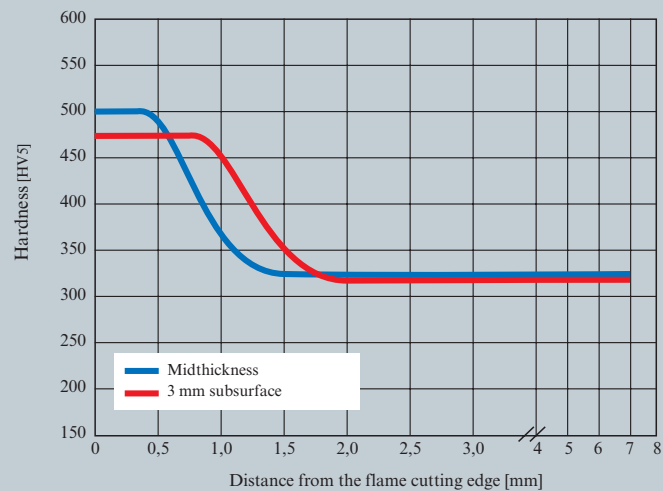
<sup>1)</sup> Max. heating temperature < 250 °C, for short periods 300 °C



If the cutting edges are cold formed in further processing, for example by bending, the zone hardened by flame cutting should be removed for all DILLIDUR steels by grinding in the area to be formed (see section „Cold forming“, p. 20).

Figure 15 shows the typical hardness profile in the heat affected zone (HAZ) of the flame cutting edge of a DILLIDUR 325 L plate. The hardness values are comparable to those obtained after water quenching. But this hardness quickly drops down to the original hardness of the workpiece.

**Figure 15:** Hardening of DILLIDUR 325 L at the flame cutting edge after oxycutting (auxiliary data, plate thickness: 15 mm)





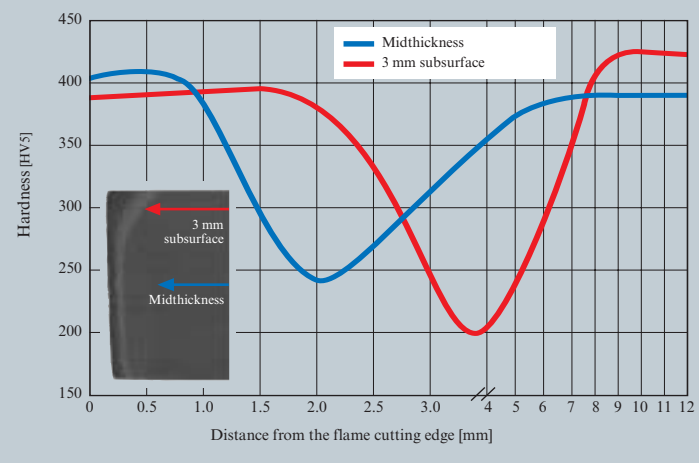
For DILLIDUR V steels, the flame cutting edge reaches the hardness of the original water-hardened material again. In between is a small softened zone, which is rather wider near the surface because of the spreading of the heating flame (see Figures 16 and 17).

DILLIDUR V steels should not be heated above 250 °C for long periods, since they would otherwise lose much of their hardness.

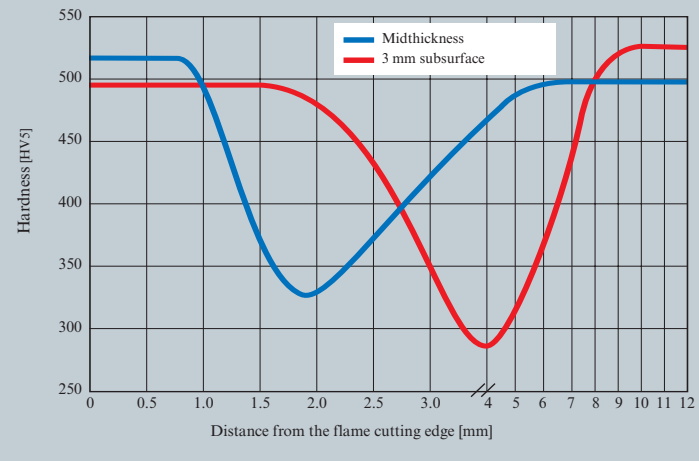
Therefore, for flame cutting parts which are unable to dissipate heat quickly enough such as small components, screen plates, lamellae, cutter blades etc., additional cooling should be provided instead of preheating.

This can be achieved, for example, by flame cutting in a water bath with the plate to be flame cut 2/3 immersed in the water so that the heat can be rapidly dissipated via the water. In this case, the resulting shrinkage force is much smaller, so that there is little risk of cracking because of the narrow heat-affected zone (HAZ). A further advantage is the tighter dimensional tolerance that can be achieved with this flame cutting method.

**Figure 16:** Hardening of DILLIDUR 400 V at the flame cutting edge after oxycutting (auxiliary data, plate thickness: 20-30 mm) and example of the flame cutting HAZ on plate edge (micrograph)



**Figure 17:** Hardening of DILLIDUR 500 V at the flame cutting edge after oxycutting (auxiliary data, plate thickness: 20-30 mm)





**Laser and plasma cutting:** The major advantages of laser and plasma cutting lie in the higher cutting performance and the narrower heat-affected zone, along with minimum heat input. With both cutting processes it is possible to cut even the smallest parts, lamellae and screen plates with low distortion and without loss of hardness (see Figure 18). With these methods it is also possible to dispense with pre-heating.

A perfect surface of the plates is a fundamental precondition for laser cutting because the laser beam must be concentrated without reflection loss and absorbed without disturbance on the so-called focus on the surface of the plate.

If required, all DILLIDUR steels can be supplied shot-blasted and coated especially for this purpose. The achievable cutting performance depends to a

great extent on the laser power and the plate thickness to be cut. With a plate thickness of 10 mm and a laser energy of 2-3 kW, cutting speeds of up to 2000 mm/min are possible.

With suitable surface treatment, e.g. the use of an emulsion, it may even be possible to improve this performance.



*Figure 18: Laser-cut screen plate made of DILLIDUR 400 V, plate thickness 12 mm*

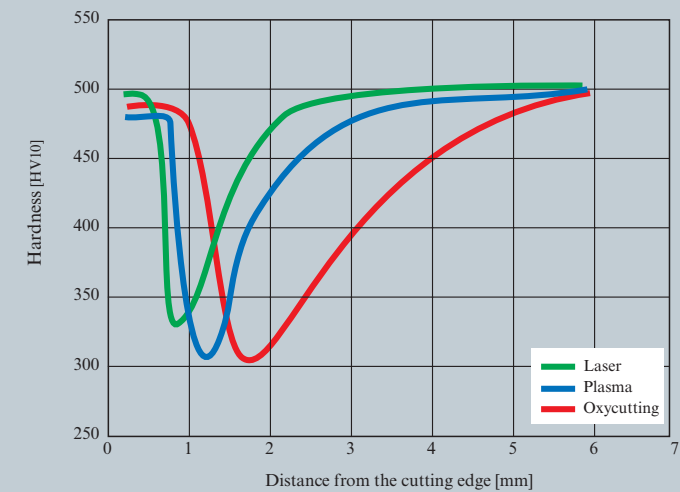




Unlike laser cutting, plasma cutting is also suitable for plate thickness above 30 mm. However, the heat affected zone is somewhat wider. Figure 19 shows the typical effect of the different cutting methods on the heat affected zone of a hardened, wear resisting steel.

**Water jet cutting:** This method is particularly suitable for cutting of DILLIDUR steels because there are no thermal effects which may induce changes in the material and impair the properties of the component. However, the cutting speed is rather slower.

**Figure 19:** Typical effect of different flame cutting processes on the heat affected zone of a hardened, wear resisting steel





*Figure 20: Welded excavator shovel made of DILLIDUR V plates  
(Illustration used with the kind permission of Schlüter Baumaschinen, Erwitte, Westphalia, Germany)*



## **Welding**

**Weldability:** With increasing alloying contents, the processing, and especially the heat control during welding, requires special care.

As long as the general rules of welding technology (EN 1011, see section “Literature“, p. 49) and the following instructions are observed, DILLIDUR 400 V and 450 V are very suitable for welding with normal welding techniques: submerged arc, manual arc and gas shielded metal arc welding.

On the contrary, the welding of DILLIDUR 275 C is more difficult because of the relatively high carbon content. Other bonding types, e.g. bolting, are preferable.

DILLINGER HÜTTE GTS points out that the following recommendations on welding are purely for information.

The wide variety of welding conditions, the construction and the consumables used have a significant effect on the quality of the welded joints. As the respective operating and

processing conditions are not known, it is not possible to guarantee in advance the mechanical properties of the weld or the lack of defects in the welds. But practical experience shows that good results are obtained if suitable welding conditions are maintained.

### **Preparation of the weld seam:**

The weld seam can be prepared by machining or by thermal cutting. At the beginning of the welding process, the seam must be bright, dry and free from flame cutting slag, rust, scale, paint and any other impurities.



**Weld fillers and consumables:**

Weld fillers must be selected in accordance with the requirements for the mechanical properties.

In most cases it is sufficient, for fillet welds and butt joints that are not subject to full stress, to use a “soft” weld filler with a low strength and hardness (yield strength  $\leq 355$  MPa). However, this is only practical if the welds can be designed to be in areas that are subject to less wear, so that the wear of the weld does not have a negative effect on the service life of the component.

Table 7 shows an overview of suitable “soft” weld fillers. The root seam should in any case be

“soft” welded so that it can fully absorb any tension which arises.

For welds subject to extreme wear, we recommend that the final pass should be carried out with special hard facing electrodes. For such applications, Table 8 shows an overview of suitable “hard” weld fillers. You should take into account that a high degree of hardness in the weld increases the risk of cold cracking.

In manual arc welding, basic-coated rod electrodes are always used because of the risk of cracks. Basic-coated rod electrodes have two outstanding properties: the toughness of the weld metal is higher and their hydrogen intro-

duction, at approx. 5 ml/100g weld metal is lower than for any other types of coating (approx. 10 to 15 ml/100g weld metal). The risk of cold cracking is therefore lower. It is essential that redrying and storage are carried out according to the instructions of the consumable manufacturer because basic coatings absorb air humidity.

Where austenitic electrodes or electrodes on a nickel basis are used, it is sometimes possible to dispense with preheating. But the use of such electrodes is generally only advisable for small seam cross-sections because of the higher costs.



**Table 7:** “Soft“ weld fillers and consumables for welding of DILLIDUR steels

**Manual arc welding**

Designation	Standard	Manufacturer
Tenacito	DIN EN 499 E 42 6 B 42 H5 – AWS A 5.1 E 7018	OERLIKON
Phoenix 120 K	DIN EN 499 E 42 5 B 32 H5 – AWS A 5.1 E 7018	THYSSEN
Fox EV 50	DIN EN 499 E 42 4 B 42 H5 – AWS A 5.1 E 7018	BOEHLER
OK 48.00	DIN EN 499 E 38 2 B 42 H5 – AWS A 5.1 E 7018	ESAB

**Gas shielded metal arc welding**

Designation	Standard	Manufacturer
Fluxofil 30	DIN EN 758 T 42 2 B C 3 – AWS A 5.20 E 70 T-5	OERLIKON
Fluxofil 31	DIN EN 758 T 42 4 B C 3 – AWS A 5.20 E 70 T-5	OERLIKON
Union K 52	DIN EN 440 G 42 A C G3 Si1 – AWS A 5.18 ER 70 S-6	THYSSEN
OK Autrod 12.51	DIN EN 440 G 42 5 M G3 Si1 – AWS A 5.18 ER 70 S-6	ESAB

**Submerged arc welding**

Designation	Standard	Manufacturer
OE S2	DIN 756 S2 – AWS A 5.17 EM 12	OERLIKON
Union S2	DIN 756 S2 – AWS A 5.17 EM 12	THYSSEN
OK Autrod 12.20	DIN 756 S2 – AWS A 5.17 EM 12	ESAB
EMS 2	DIN 756 S2 – AWS A 5.17 EM 12	BOEHLER

To combine with fluoride-alkaline powders, TYPE FB according to DIN EN 760, e.g. A FB 1 55 AC



**Table 8:** “Hard“ weld fillers and consumables for welding of DILLIDUR steels

**Manual arc welding**

Designation	Standard	Manufacturer
Tenacito 80	DIN EN 757 E 69 4 Mn2NiCrMo B H5 – AWS A 5.5 E 11018-G	OERLIKON
Tenacito 100	DIN EN 757 E 89 2 Mn2Ni1CrMo B H5 – AWS A 5.5 E 12018-G	OERLIKON
SH Ni2 K 90	DIN EN 757 E 55 5 2 NiMo B – AWS A 5.5 E 10018-M	THYSSEN
SH Ni2 K 130	DIN EN 757 E 89 2 Mn2Ni1CrMoB – AWS A 5.5 E 12018-M	THYSSEN

**Gas shielded metal arc welding**

Designation	Standard	Manufacturer
Union NiMoCr	AWS A 5.28 ER 100 S-1	THYSSEN
Fluxofil 41	DIN EN 758 T 50 6 1NiMo B C(M) 3 – AWS A 5.29 E 90 T5-G	OERLIKON
Fluxofil 42	AWS A 5.29 E 110 T5 K4	OERLIKON

**Submerged arc welding**

Designation	Standard	Manufacturer
Union S3 Mo	DIN EN 756 S3Mo – AWSA 5.23 EA 4	THYSSEN
Union S3 NiMoCr	AWSA 5.23 ~ EM2	THYSSEN
Fluxocord 41	AWSA 5.23 F9A8-EC-G	OERLIKON
Fluxocord 42	AWSA 5.23 F11 A8-EC-F5	OERLIKON

to combine with fluoride-alkaline powders, type FB according to DIN EN 760, e.g. A FB 1 55 AC

**Prevention of cold cracking:**

Like all hardened wear resistant steels, DILLIDUR steels can under unfavourable conditions also tend to form cold cracks in the hardened structure at the weld.

Given that the cracks appear only several hours after welding, checking for cracks should be made 48 hours after welding at the earliest.

But cold cracking can be avoided if suitable precautions are adopted during welding, and especially if two factors which favour cracking are excluded: hydrogen in the weld metal and intrinsic constraint. A third factor, hardening in the heat-affected zone of DILLIDUR steels, can only be controlled to a limited extent because of the higher alloy content of the base material and the weld fillers, depending on the steel type. Inclusion of hydrogen atoms at

the grain boundaries of the weld metal structure and on the fusion line are the main causes of cracking. The hydrogen enters the weld through moist weld fillers, films of moisture on the weld edges or the atmosphere surrounding the arc. The hydrogen entry must be reduced by selecting suitable weld fillers, keeping them dry in storage and especially by warming up the component to be welded or the weld area.

The higher temperature leads to a delay in the cooling of the weld after welding, which means that the hydrogen has more time to diffuse out. This process mainly takes place in the temperature range between 300 and 100 °C.

Heat control not only refers to the heating of the seam at the beginning of the welding process, it also refers to adherence to a certain minimum temperature throughout the

whole welding process (interpass temperature). In gas shielded metal arc welding, only comparatively small amounts of hydrogen are introduced to the weld metal (< 2 ml/100 g), so that preheating can often be dispensed for the DILLIDUR 400 V and 450 V series when using welding wires of a lower strength.

Because of the generally higher energy input per unit length that is used for submerged arc welding, the danger of cold cracking is reduced here by comparison with manual metal arc welding as long as the powder is redried and stored in accordance with its manufacturer's instructions.

Experience shows that submerged arc welding should be used only for DILLIDUR 400 V. If the heat input per unit length is higher than 2.5 kJ/mm, the given preheating temperatures can generally be reduced by about 30 °C.



*Figure 21: Welded truck dumping body made of DILLIDUR 400 V, plate thickness 10 mm*





Preheating temperatures for welding of DILLIDUR steels are shown in Figures 22 to 25. They show the recommended minimum preheating temperatures in relation to the plate thickness, and thus the carbon equivalent CET and the hydrogen content of the fused weld filler.

The plate thickness does not refer to the combined plate thickness. The criterion is always the thickest plate in the construction to be welded.

At the beginning of the welding process, the whole length of the seam shall have reached the preheating temperature. A zone of

about 100 mm width (or at least 4 times the plate thickness) on both sides of the weld shall have reached the preheating temperature as well. For multiple layer welding, you must also adhere to the preheating temperature as a minimum interpass temperature.

The danger that cracks may occur in welded joints as a result of residual stresses is particularly high when the seam volume is only partly filled. Therefore, cooling below the prescribed interpass temperature must be avoided during the whole welding process. In the interest of lower residual stresses, harsh

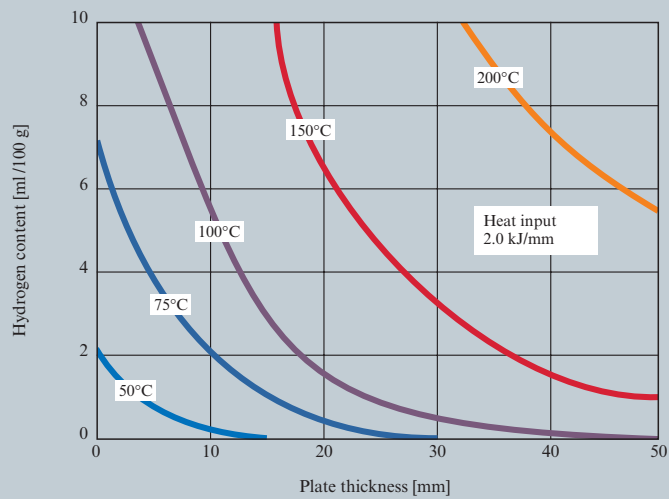
cross-sectional transitions and concentrations of welds must be avoided. Also make sure that the components to be welded form a good fit and that the welds are free from notches as far as possible. An advantageous weld sequence can also reduce the residual stresses.

In principle, the weld sequence should be selected to ensure that the individual components can shrink freely for as long as possible.

Root welds and tack welds should be sufficiently thick taking into account the minimum preheating temperature.



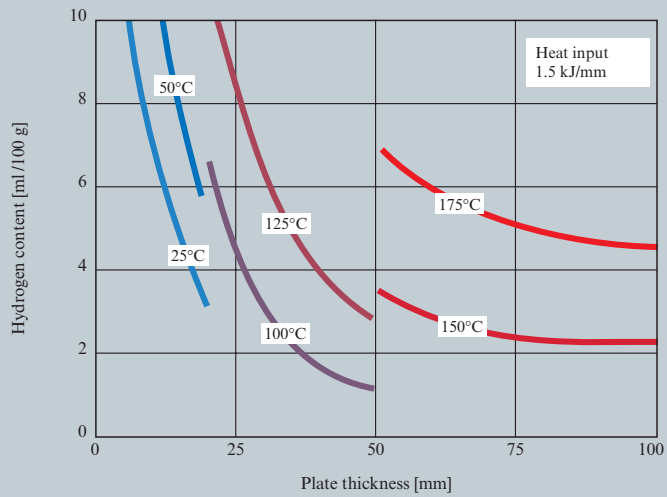
**Figure 22:** DILLIDUR 325 L: recommended preheating temperatures in relation to the plate thickness and hydrogen content of the fused weld filler



Hydrogen content HDM according to ISO 3690



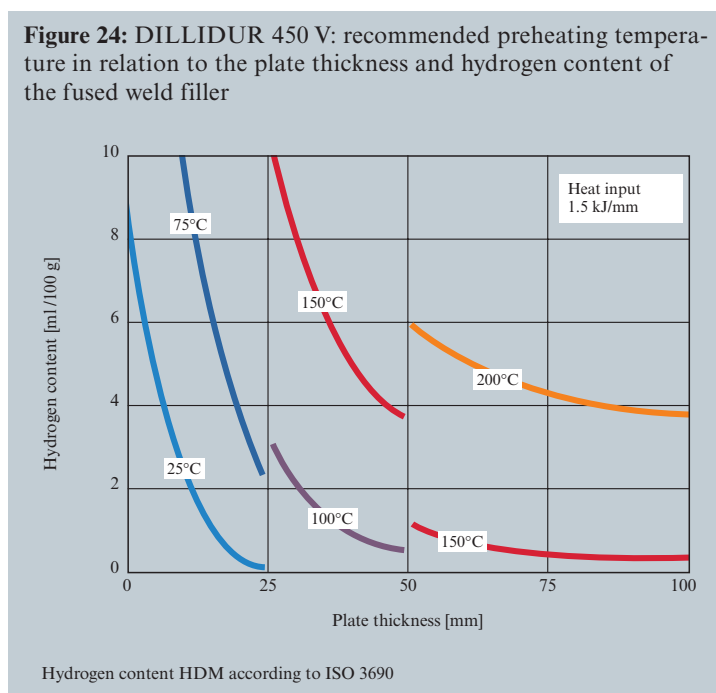
**Figure 23:** DILLIDUR 400 V: recommended preheating temperatures in relation to the plate thickness and hydrogen content of the fused weld filler



Hydrogen content HDM according to ISO 3690

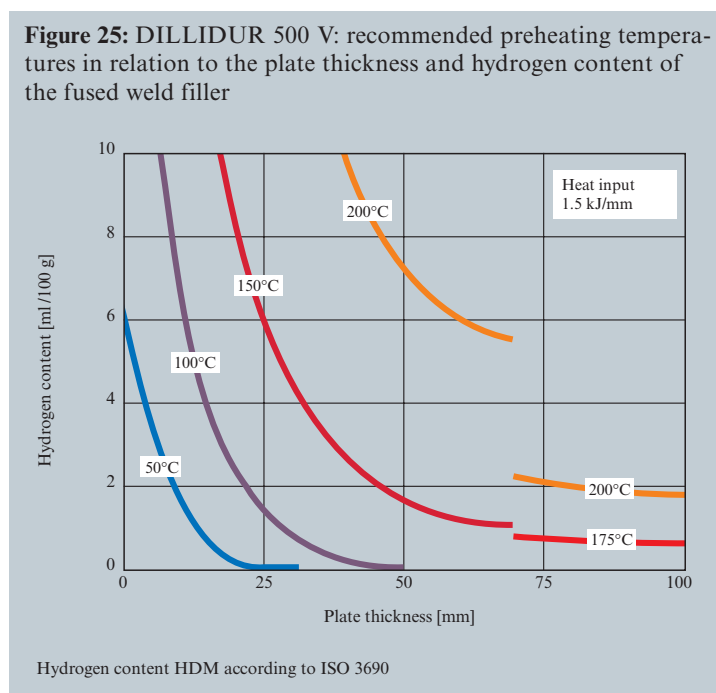


**Figure 24:** DILLIDUR 450 V: recommended preheating temperature in relation to the plate thickness and hydrogen content of the fused weld filler





**Figure 25:** DILLIDUR 500 V: recommended preheating temperatures in relation to the plate thickness and hydrogen content of the fused weld filler





**Hard facing:** Components which are subject to extreme local wear load can be additionally protected by hard facing through weld overlay. Application of welded wear protection layers is possible for all DILLIDUR steels.

It must be taken into account that weld overlay changes the original properties of the plate within the heat affected zone, especially for DILLIDUR V steels.

When the weld layer has been worn away, the softened basic material may then wear faster than was to be expected for the material in its original condition, so that in the long-term this wear protection may produce inferior results if the cap pass is not replaced in time. For information about suitable weld fillers for hard facing, we recom-

mend that you consult the respective manufacturers.

#### **Machining**

DILLIDUR steels are very well suited for machining in spite of their high strength and hardness. However, some basic rules must be observed when machining these hardened steels. Vibrations should be avoided. It is therefore advisable to work on a machine that is as rigid as possible and to keep the gap between the workpiece and the machine (support) to a minimum. Similarly, it is advisable to fix the workpiece firmly to the workbench.

Depending on the type of machining work, sufficient cooling should be ensured. An interruption of the coolant supply or insufficient coolants and lubricants can lead to over-

heating of the cutting edge, which can lead to increased wear of the cutting edge and, in extreme cases, to breakage of the tool. Please note the relevant information given by the tool manufacturer. To minimize maintenance costs and increase the service life of the tools, they should regularly be checked for wear (wear band) and ground.

The recommendations given in the following tables for the selection of tools and the machining of DILLIDUR steels are guidelines which may lead to different results for different machines. The validity of these recommendations should be checked by the processing specialist on site. Detailed information about machining and tool selection can be obtained by consulting tool manufacturers or DILLINGER HÜTTE GTS.



**Drilling:** DILLIDUR steels are well suited for drilling in spite of their high hardness. Suitable tools are cobalt-alloyed HSS twist drills, twist drills with brazed carbide cuttings, solid carbide twist drills (with internal cooling where appropriate) and

drills with indexable inserts. For stable drills, the feed rate should be set rather higher when machining begins to ensure that the tool engages firmly. This helps to reduce vibrations. Before the drill is completely through the material, feed should be inter-

rupted briefly. This reduces the tension on the machine and the tool and avoids breaking of the cutting edges. Details on the selection of tools, cutting speeds and feed rates can be found in Table 9.

**Table 9:** Recommendations for drilling DILLIDUR 325 L, 400 V, 450 V and 500 V

DILLIDUR	Tool type (Cutting material)	Cutting speed $V_c$ [m/min]	Feed $f$ [mm/rev.] depending on diameter		
			5 – 15 mm	20 – 30 mm	30 – 40 mm
325 L	Twist drill with brazed carbide cutting or solid carbide twist drill <sup>1)</sup>	8 – 12	0.02 – 0.12	0.10 – 0.20	0.15 – 0.25
	Drill with indexable inserts <sup>2)</sup>	80 – 90	0.06 – 0.075	0.10 – 0.11	0.11 – 0.12
400 V	Solid carbide heavy duty drill (TIN) <sup>1)</sup>	35 – 50 without internal cooling 40 – 70 with internal cooling	0.06 – 0.16	0.18 – 0.25	–
	Cobalt-alloyed HSS-twist drill <sup>2)</sup>	8 – 10	0.05 – 0.16	0.20 – 0.25	–
	Drill with indexable inserts <sup>2)</sup>	60 – 70	–	0.10 – 0.12	0.12
450 V	Solid carbide heavy duty drill (TIN) <sup>1)</sup>	35 – 50 without internal cooling 40 – 70 with internal cooling	0.06 – 0.16	0.18 – 0.25	–
	Cobalt-alloyed HSS-twist drill <sup>2)</sup>	6 – 10	0.05 – 0.15	0.20 – 0.25	–
	Drill with indexable inserts <sup>2)</sup>	50 – 60	–	0.10 – 0.12	0.11
500 V	Solid carbide heavy duty drill (TIN) <sup>1)</sup>	35 – 50 without internal cooling 40 – 70 with internal cooling	0.06 – 0.16	0.18 – 0.25	–
	Cobalt-alloyed HSS-twist drill <sup>2)</sup>	4 – 10	0.05 – 0.13	0.18 – 0.25	–
	Drill with indexable inserts <sup>2)</sup>	40 – 50	–	0.10	0.10

<sup>1)</sup> Results with tools from Fette GmbH, Schwarzenbek, Germany

<sup>2)</sup> Results with tools from Ferrotec, Bielefeld, Germany

Coolant/lubricant: emulsion



**Countersinking:** Cylindrical and conical countersinking can best be made in hardened plates if the tool has a pilot. This prevents vibrations. The use of three-edged countersinkers can also contribute to a reduction of vibrations. Recommendations for cutting speed and forward feed are given in Table 10.

**Tapping:** Screw threads can generally be tapped by machine. Information on the selection of tools, cutting speeds and speeds can be found in Table 11.

**Sawing:** When using a band saw to saw DILLIDUR steels, we recommend grinding the flame cutting edge 1-2 mm deep in the area to be sawn and sawing the smallest cross-section. In practice, cobalt-alloyed or carbide-tipped saw blades have proved themselves there. We recommend a cutting speed of about 18 m/min with good cooling.

**Table 10:** Recommendations for countersinking DILLIDUR 325 L, 400 V, 450 V and 500 V

DILLIDUR	Tool type (Cutting material)	Cutting speed $V_C$ [m/min]	Feed f [mm/rev.] depending on diameter	
			15 – 30 mm	30 – 60 mm
325 L 400 V 450 V 500 V	Countersinker made of solid carbide or with reversible carbide tips <sup>1)</sup>	30 – 40 30 – 40 20 – 30 10 – 20	0.10 – 0.15	0.15 – 0.25

<sup>1)</sup> Results with tools from Fette GmbH, Schwarzenbek, Germany and from Ferrotec, Bielefeld, Germany

Coolant/lubricant: emulsion

**Table 11:** Recommendations for tapping DILLIDUR V steels

DILLIDUR	Tool type (Cutting material)	Cutting speed $V_C$ [m/min]	Speed n [rpm] depending on diameter				
			M10	M16	M20	M30	M42
400 V 450 V 500 V	Manual or machine tap HSS-Co <sup>1)</sup>	1.5 – 3.5	50 – 120	40 – 80	30 – 60	20 – 40	15 – 30

<sup>1)</sup> Results with tools from Ferrotec, Bielefeld, Germany

Coolant/lubricant: emulsion





**Milling:** DILLIDUR steels can be processed with tools made of high-speed steel (HSS, TiN, TiCN-coated) and with tools equipped with indexable inserts. Please note that flame cut edges may show significantly higher hardness values than the rest of the material. Therefore, the first cut should be at least 2 mm deep, i.e. should go far enough below the heat affected zone. To mill DILLIDUR V steels, it is advisable to use round inserts.

Experience has shown that this geometry is superior to a planar face milling geometry (i.e. with a 45° angle of incidence). The use of indexable inserts with a broad cutting edge chamfer also minimizes wear. Instead of cooling with emulsion, dry machining is recommended in this case. But the use of compressed air or minimal quantity lubrication can lead to further improvements in the service life. Indexable inserts are sensitive

to vibrations. Therefore, all possible measures must be adopted to reduce vibrations, e.g. firm clamping of the workpiece. If large surfaces need to be processed, it is advisable to machine the plate alternately on both sides, as this enables distortion of the workpiece to be avoided. Recommendations for the cutting speed and feed rate for face and edge milling are given in Tables 12 and 13.

**Table 12:** Recommendations for face milling DILLIDUR V steels

DILLIDUR	Tool type (Cutting type)	Cutting speed $V_c$ [m/min]	Feed per tooth $f_z$ [mm]
400 V	Profile milling cutter/(FC 220N) <sup>1)</sup> Facing cutter/(HC-P20+TiN)	130 – 150	0.10 – 0.12
450 V	Profile milling cutter/(FC 220N) <sup>1)</sup> Facing cutter/(HC-P20+TiN)	100 – 130	0.10 – 0.12
500 V	Profile milling cutter/(FC 220N) <sup>1)</sup> Facing cutter/(HC-P20+TiN)	80 – 90	0.10 – 0.12

<sup>1)</sup> Results with tools from Fette GmbH, Schwarzenbek, Germany  
(TwinCut profile milling cutter:  $d = 125$  mm, number of teeth:  $z = 8$ )

Coolant/lubricant: none

**Table 13:** Recommendations for edge milling DILLIDUR V steels

DILLIDUR	Tool type (Cutting type)	Cutting speed $V_c$ [m/min]	Feed per tooth $f_z$ [mm]
400 V	Roughing cutter/(FC 220N) <sup>1)</sup> (HC-P20+TiN)	145 – 155	0.13 – 0.15
450 V	Roughing cutter/(FC 220N) <sup>1)</sup> (HC-P20+TiN)	100 – 140	0.15 – 0.17
500 V	Roughing cutter / (FC 220N) <sup>1)</sup> (HC-P20+TiN)	85 – 95	0.17 – 0.19

<sup>1)</sup> Results with tools from Fette GmbH, Schwarzenbek, Germany  
(TwinCut roughing cutter:  $d = 63$  mm, number of teeth:  $z = 3$ )

Coolant/lubricant: none



## Nitriding

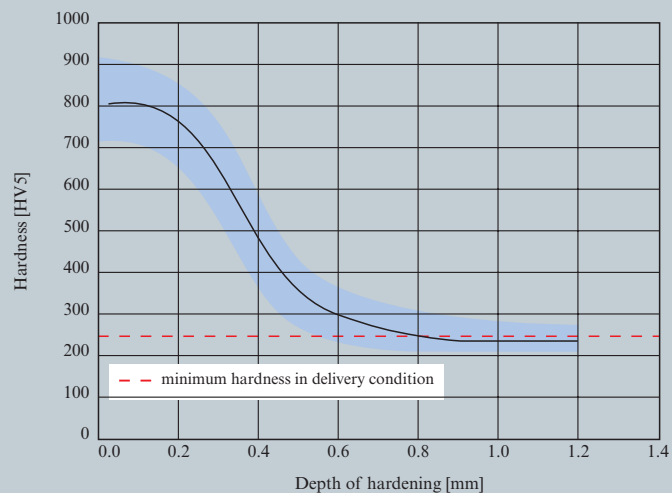
To increase the wear resistance near the surface, it can be advisable for special applications to carry out additional nitriding of DILLIDUR steels, for example for moulds or pressure rams.

During nitriding, the hardness is increased by the diffusion of nitrogen into the surface of the workpiece, which leads to the formation of hard nitrides.

Depending on the process, nitriding is carried out at temperatures between 500 and 600 °C.

DILLIDUR L and V steels are particularly suitable for nitriding due to their content of nitride-forming elements such as aluminium, silicon, chromium, niobium, titanium and vanadium. For instance, gas nitriding of DILLIDUR 325 L makes it possible to achieve a surface hard-

**Figure 26:** Typical hardness profile after gas nitriding of DILLIDUR 325 L, nitriding duration approx. 80 hours, nitriding temperature 530 °C



ness of up to 920 HV and a nitride hardening depth of up to 0.7 mm at 340 HV (see Figure 26). Due to a tempering effect, the hardness in the core of the plate drops to the level of the minimum hardness in delivery condition.

For the selection of the most appropriate DILLIDUR steel (including the quality DILLIDUR NT that was developed specifically for nitriding), please contact DILLINGER HÜTTE GTS.



## LITERATURE

### **Additional reading for the section “A Longer Life for your Machinery“**

Uetz U.: Abrasion und Erosion,  
Carl Hanser Verlag, 1986, S. 2-25

Zum Gahr K. H.: Entwicklung  
und Einsatz verschleißfester  
Werkstoffe. Materialwissen-  
schaft und Werkstofftechnik 19  
(1988), S. 223-230

DIN 50 320 (1979): Verschleiß.  
Beuth Verlag GmbH, Berlin,  
(withdrawn)

DIN 50 321 (1979): Verschleiß-  
Meßgrößen. Beuth Verlag  
GmbH, Berlin (withdrawn)

GfT Arbeitsblatt 7:  
Tribologie – Definitionen,  
Begriffe, Prüfung. Gesellschaft  
für Tribologie e.V., Moers, 2002

### **Additional reading for the section “The Fabrication Properties of DILLIDUR“**

Stahl Merkblatt 252: Thermo-  
sches Schneiden von Stahl.  
Stahl-Informations-Zentrum,  
Düsseldorf, 1985

Hermann F. D.: Thermisches  
Schneiden - Die schweißtechni-  
sche Praxis. DVS-Berichte Band  
13. DVS-Verlag, Düsseldorf,  
1979

EN 1011 (Part 1: 05/2002,  
Part 2: 01/2001): Recommen-  
dations for welding of metallic  
materials, CEN

Uwer D. et al: Schweißen mo-  
derner hochfester Baustähle.  
Stahl u. Eisen 112 (1992) 4,  
S. 29-35

Stahl Merkblatt 381: Schweißen  
unlegierter und niedriglegierter  
Baustähle. Stahl-Informations-  
Zentrum, Düsseldorf, 1989

ISO 3690 (2000): Welding and  
allied processes – Determination  
of hydrogen content in ferritic  
steel arc weld metal. IIW

Stahl Merkblatt 447: Nitrieren  
und Nitrocarburieren. Stahl-  
Informations-Zentrum, Düssel-  
dorf, 1983



---

## INDEX

Bending radius .....	20f
Carbon equivalent .....	12, 39ff
Chemical analysis .....	12
Cold forming .....	10, 20f
Countersinking .....	46
Die opening .....	20f
Drilling .....	45
Elongation .....	17
Flame cutting, oxyacetylene .....	27ff
Gas shielded metal arc welding .....	33ff
Hard facing .....	44
Hardness .....	15ff
Hardening .....	15
Heat affected zone (HAZ) .....	27ff, 31
Heat input per unit length .....	37, 40ff
High-temperature strength .....	18ff
Hot forming .....	10, 23ff
Hydrogen content .....	37ff
Impact toughness .....	17
Laser cutting .....	30
Machining .....	10, 44ff
Manual arc welding .....	33ff
Microstructure .....	13, 15
Milling .....	47
Minimum preheating temperature .....	27, 39ff
Nitriding .....	48
Plasma arc cutting .....	30f
Residual stresses .....	39
Sawing .....	46
Submerged arc welding .....	33ff
Susceptibility to cold cracking .....	37ff
Tapping .....	46
Tempering .....	23ff
Tensile strength .....	17ff
Through thickness hardening .....	18
Toughness .....	10, 17
Tribological system .....	6ff
Water jet cutting .....	31
Water quenching .....	15ff, 26
Wear types and mechanisms .....	7ff
Weldability .....	10, 33ff
Weld fillers and consumables .....	33ff
Yield strength .....	17ff



---

## SALES ORGANISATIONS

### **Germany**

Vertriebsgesellschaft  
Dillinger Hütte GTS  
Postfach 104927  
70043 Stuttgart  
Tel: +49 7 11 61 46-300  
Fax: +49 7 11 61 46-221

### **France**

DILLING-GTS Ventes  
5, rue Luigi Cherubini  
93212 La Plaine Saint Denis  
Cedex  
Tel: +33 1 71 92 16 74  
Fax: +33 1 71 92 17 98

For your local representative  
please contact our coordination  
office in Dillingen  
Tel: +49 68 31 47 23 85  
Fax: +49 68 31 47 99 24 72



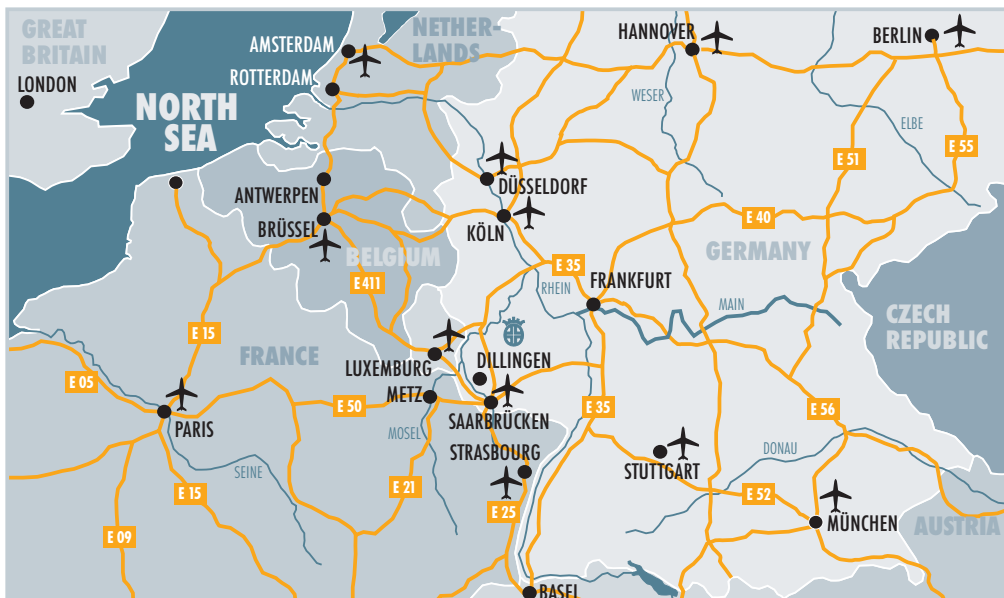
### AG der Dillinger Hüttenwerke

P. O. Box 1580  
D-66748 Dillingen/Saar  
Tel: +49 68 31 47-21 46  
Fax: +49 68 31 47-30 89

e-mail: [info@dillinger.biz](mailto:info@dillinger.biz)  
<http://www.dillinger.de>

#### General note (liability):

Any information given about the characteristics or possible use of materials and products only constitutes a description. Any assurances concerning the existence of specific properties or suitability for a specific purpose always require a special written agreement.



How to find us



